



AWS
COMMERCIAL

Architectural Series | Series 467
Architectural Awning /Casement Window (Truth Hardware)

Overview

This high performance awning and casement window has been designed to accept Truth™ Hardware. This allows us to offer very large casements and awnings fitted with scissor type winders with jamb to stile latches that secure the sashes in the closed position.

Key Features

- This high performance awning and casement window has been designed to accept Truth™ Hardware. This allows us to offer very large casements and awnings fitted with scissor type winders with jamb to stile latches that secure the sashes in the closed position.
- The extra strong sashes allow large sash windows to be fabricated for high wind load areas. Successfully tested to resist 450Pa water.
- Fixed sidelights/lowlights and highlights can be single or double glazed.
- The perimeter frame has been designed to make installation into brick veneer and cavity brick easier with built-in nailing fins (weather bars). The sub-sill that comes with this window also has a built-in nailing fin.
- The Truth™ hardware can resist very high negative wind loads with the use of winders and side latches.
- Series 467 accepts flyscreens that tuck into head and sill recess.
- On casements it's possible to clean the external glass face when the sash is in the 90° open position.
- The nailing fin frame has several important features that are worth highlighting:
 - Built-in nailing fin is more waterproof.
 - Frame accepts height adjustable galvanised M.S. building-in lug.
 - Sub-sill has external recess to accept PVC sill flap.
- Sub-sills are standard on Series 467.

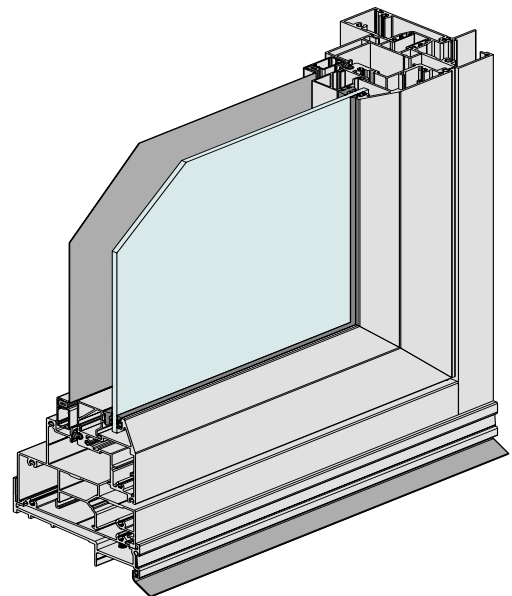

| | |
|-------------------------|--------|
| Maximum Panel Height | 2100mm |
| Maximum Panel Width | 1200mm |
| Maximum Glass Thickness | ≤ 24mm |

Subject to individual site conditions. Contact AWS Technical Support for information.



WERS RATED PRODUCT



ENHANCED ACOUSTIC PERFORMANCE



3D & 2D CAD FILES AVAILABLE



PRODUCT INFORMATION AVAILABLE AT
WWW.AWSCOMMERCIAL.COM.AU



SPECIFIER ASSISTANCE AVAILABLE

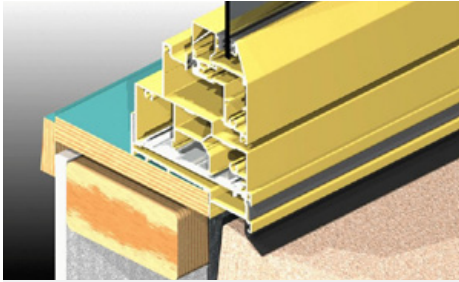

Custom sub-sill (flashing tray) standard on 467 windows.

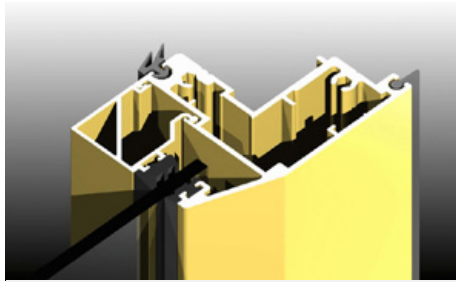

Custom sash designed to accept Truth™ hardware.



Nailing fin jamb designed to go into brick veneer construction.

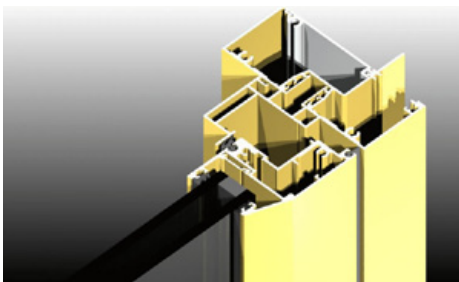

Accepts glazing up to 25mm double glazed units.

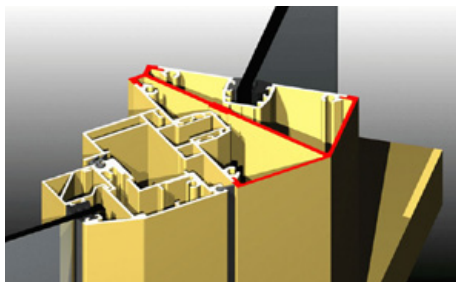

467 series can be coupled and adapted in various junction details.

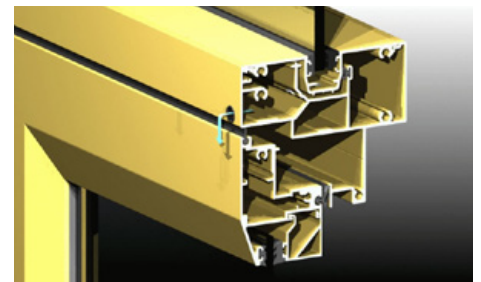

Concealed drainage designed to shed water more efficiently.

Typical Configurations

Awning Style

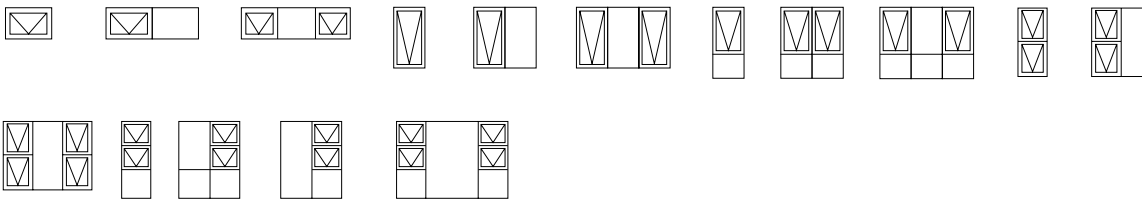

Casement Style

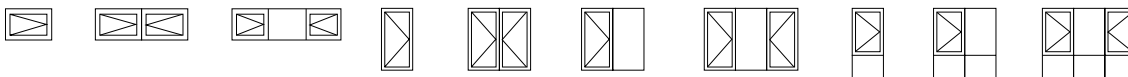

WERS RATINGS

The table below lists some of the WERS rated glass and frame combinations for this system. For a complete list of all rated glass and frame combinations refer to the Series 467 WERS Data Sheet.

| Glass Description | COOLING | HEATING | Uw | SHGCw | Tvw | Inf |
|-------------------|---------|---------|------|-------|------|------|
| 6EVanSpB | 51% | 19% | 6.04 | 0.26 | 0.23 | 0.12 |
| 10.38LamClr | 45% | 28% | 5.85 | 0.37 | 0.38 | 0.12 |
| 6.38CPClr/12Ar/6 | 51% | 49% | 4.28 | 0.39 | 0.43 | 0.12 |
| 10.38LamGy/8Ar/6 | 66% | 27% | 4.81 | 0.14 | 0.06 | 0.12 |