



## Commercial Series | Series 456 Commercial Awning Window

### Overview

Series 456 incorporates the basic residential awning sashes into bold square commercial framing with dedicated head, sill and jamb adaptors. A popular choice in both residential and commercial building applications.

### Key Features

- Residential awning sashes inlaid directly into shopfront framing.
- Dedicated head and sill to accept awning sashes with manual chain winders with Standard 30mm or alternative 44mm nailing fin jambs. We also have a double glazed
- 44mm nailing fin frame for those projects with double glazed fixed lights.
- Complies with AS2047, with a high water resistance of 450Pa. With a very low air infiltration that makes this product suitable for air-conditioned buildings.
- Besides the standard manual chain winders the awning sashes can be fitted with concealed electric chain winders or cam handles.
- Flyscreens can be fitted behind awning sashes with winders.
- Wrap around light sashes will accept glass up to 6.76mm thick, we also have wrap around sashes that will accept 20mm IGU's. The heavy duty beaded sash will accept glass from 4mm to 20mm thick.
- Fixed lowlights can be glazed from the inside in elevated situations by reversing the removable glazing beads.
- Fixed lights can be single or double glazed with glass with glass up to 24mm thick.
- Nailing fin frame makes the product suitable for cavity brick and brick veneer construction.
- Dedicated 90° and 135° couplers.

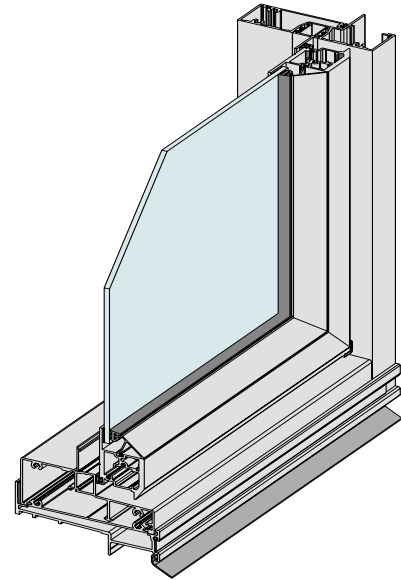

Maximum Panel Height	2100mm
Maximum Panel Width	1210mm
Maximum Glass Thickness	≤ 20mm

*Subject to individual site conditions. Contact AWS Technical Support for information.*



3D & 2D CAD FILES AVAILABLE



PRODUCT INFORMATION AVAILABLE AT  
[WWW.AWSCOMMERCIAL.COM.AU](http://WWW.AWSCOMMERCIAL.COM.AU)



SPECIFIER ASSISTANCE AVAILABLE

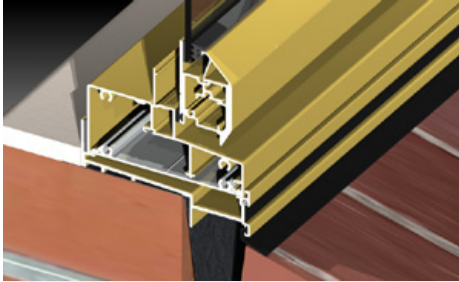

Series 456 windows come standard with integrated sub-sill.

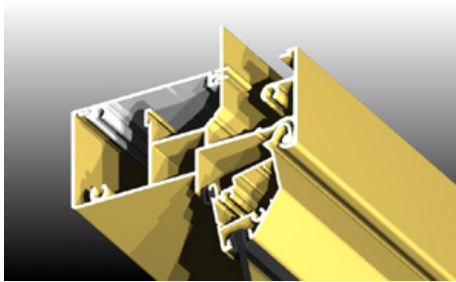

Sashes hang on built-in hook hinges.

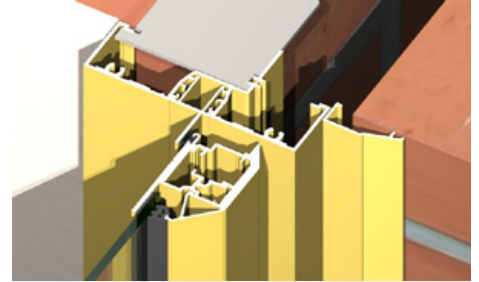

Standard 30mm nailing fin frame standard or alternative 44mm wide jamb.

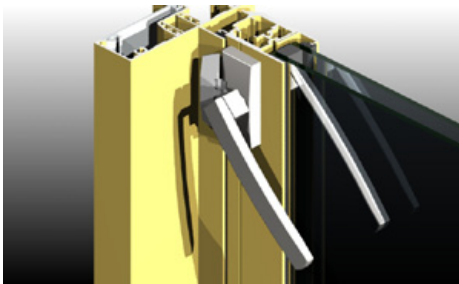

Custom stainless steel ICON™ cam handles available for casement sashes.

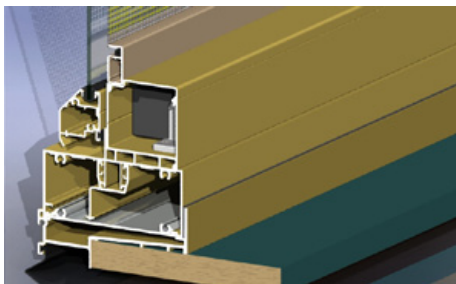

For the ultimate finish we can fit concealed electric winders.

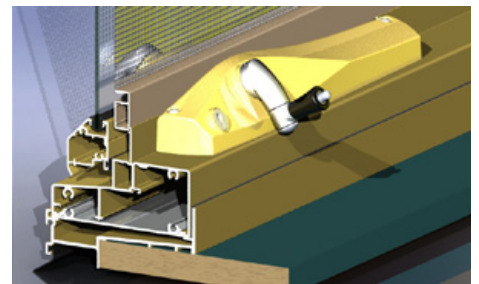

Manual chain winders are standard on Series 456 awning sashes.

## Typical Configurations

### Awning Style

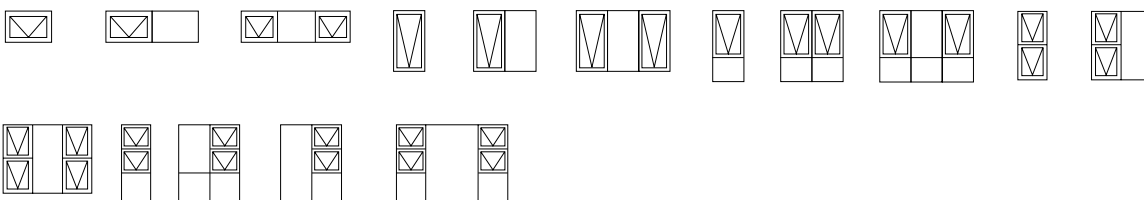

### Casement Style

